



# SSC GD 2025



## अवसर वेच

# REASONING

# NON VERBAL REASONING

Part -2

LIVE 16-08-2024 07:00 AM



निर्देश ( प्रश्न संख्या 1 से 6 ) : निम्नलिखित प्रश्न का सही जलप्रतिबिम्ब ज्ञात कीजिए ?

1.

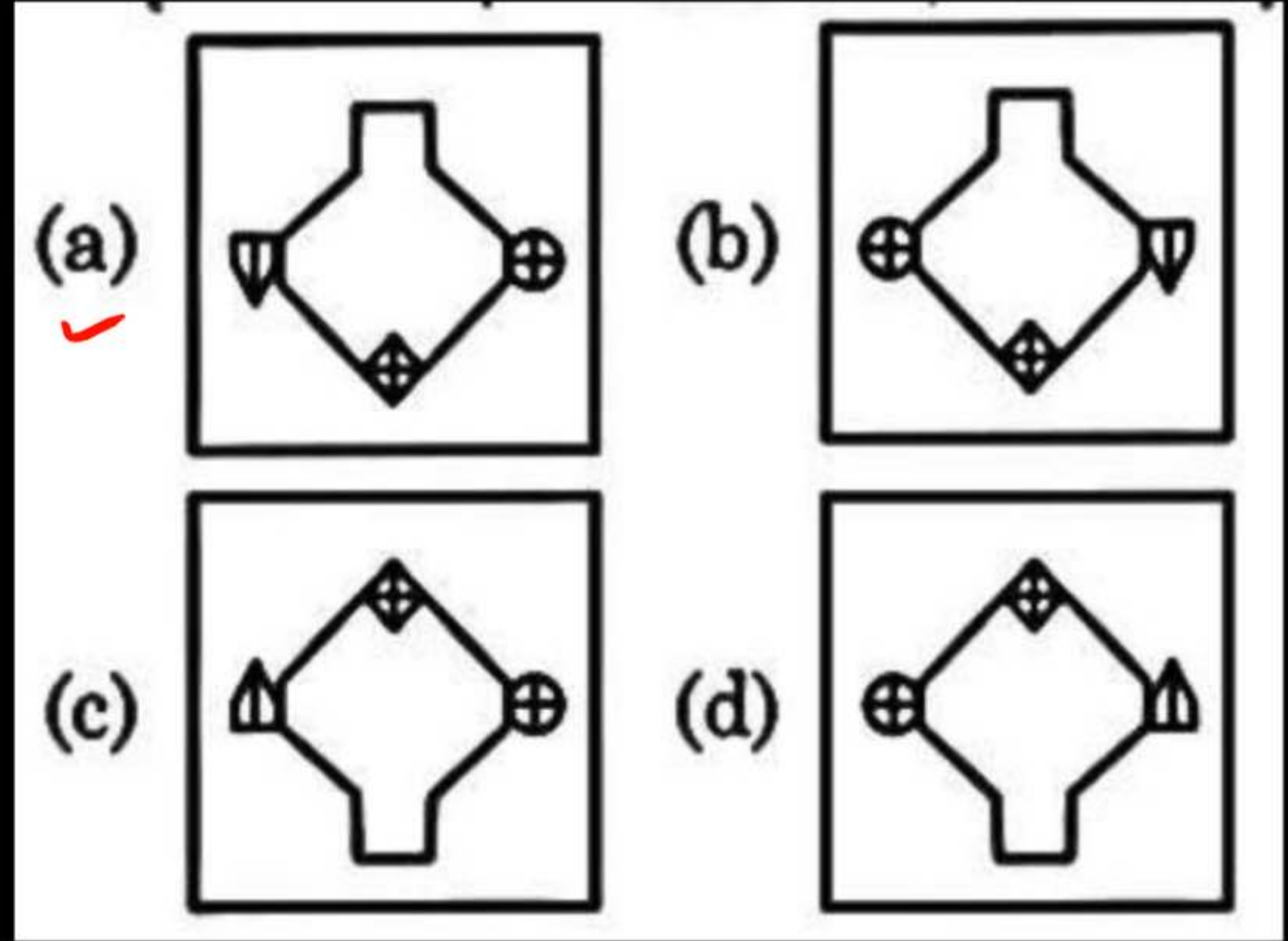
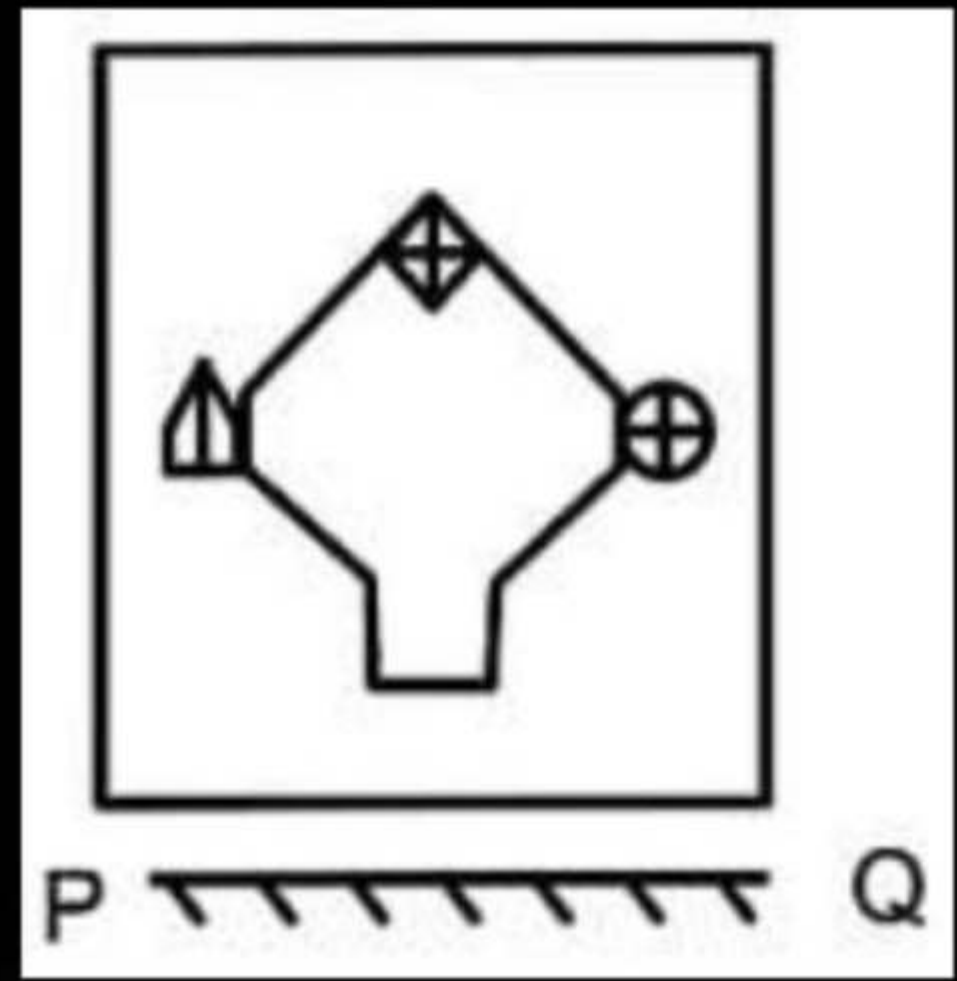



3.

C L k v 3 8 z  
M \_\_\_\_\_ N

- (a) C Γ K Λ ε 8 ζ
- (b) C Γ κ Λ 3 8 ζ
- (c) C Γ K Λ 3 8 ζ
- (d) ζ 8 ε 3 v κ C

4.

X C W V 5 2 3 A  
M \_\_\_\_\_ N

(a) X C M V 2 5 3 A

(b) X C M A 5 5 3 A

✓ (c) X C M A 2 5 3 A

(d) X C M A 2 2 3 A

5.

F G R z c 6 n W  
M \_\_\_\_\_ N

(a) F G R z c 9 n W

(b) F G R z c 6 n W

✓ (c) F G R z c 6 n W

(d) W n 6 c z R G F

6.

6 Z k B M V d  
M————— N

- (a) b V M B k Σ ϑ
- (b) ϑ Σ K B W Λ ϑ
- (c) ϑ Σ k B M V ϑ
- (d) ϑ Z k B W Λ ϑ

7.

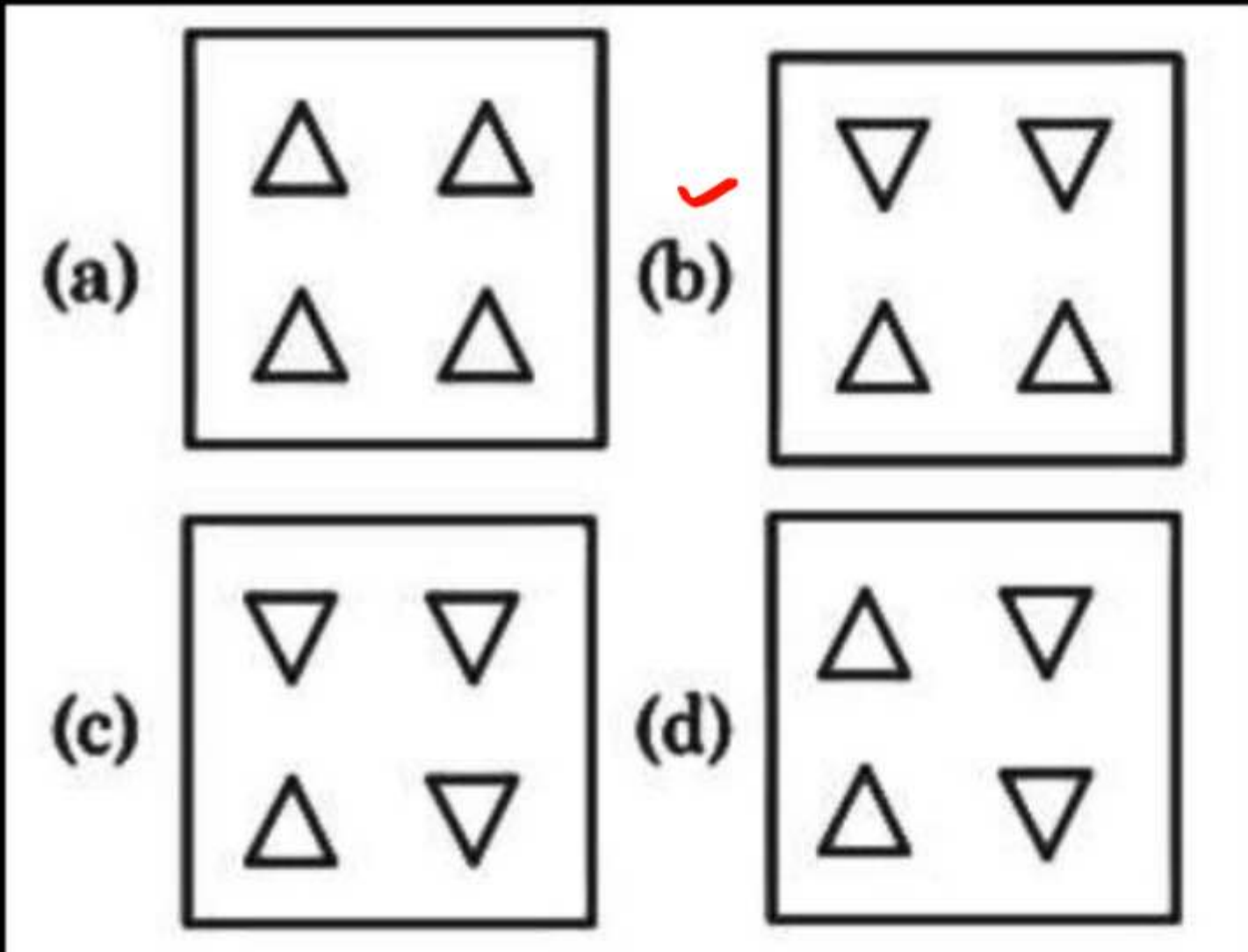
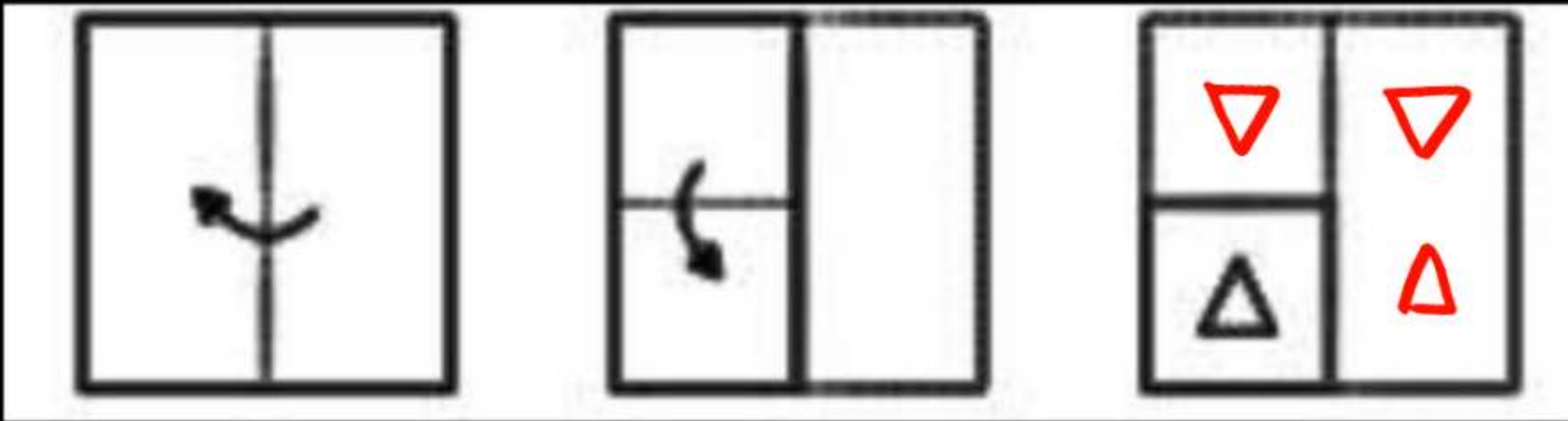

8.

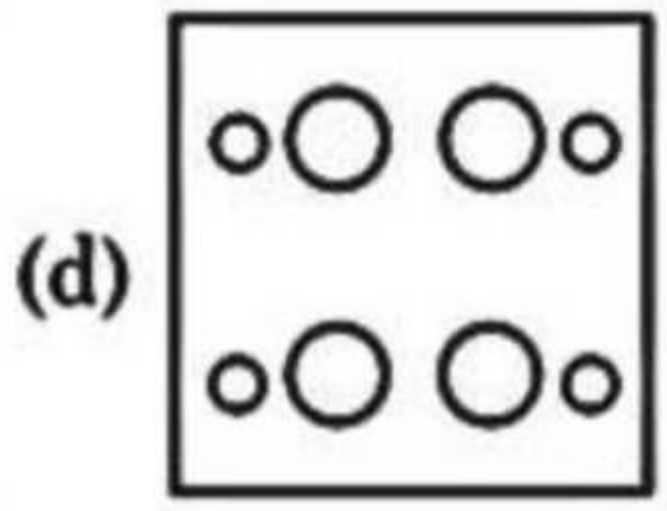
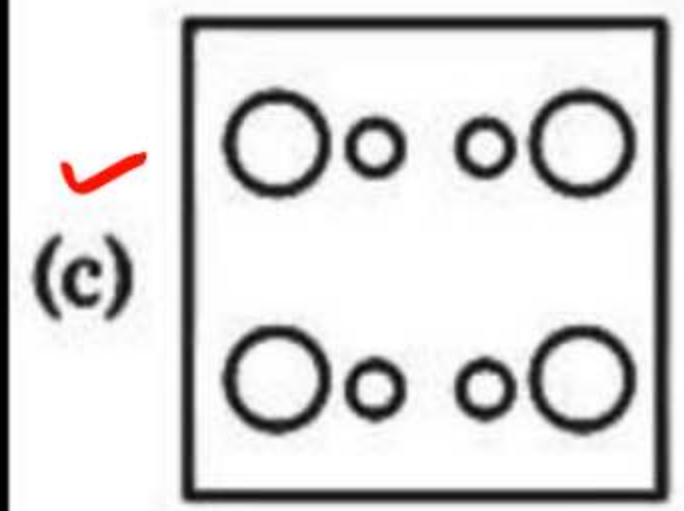
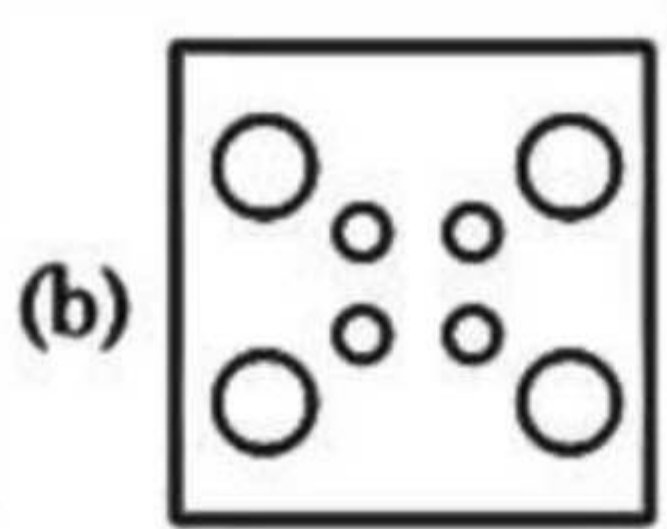
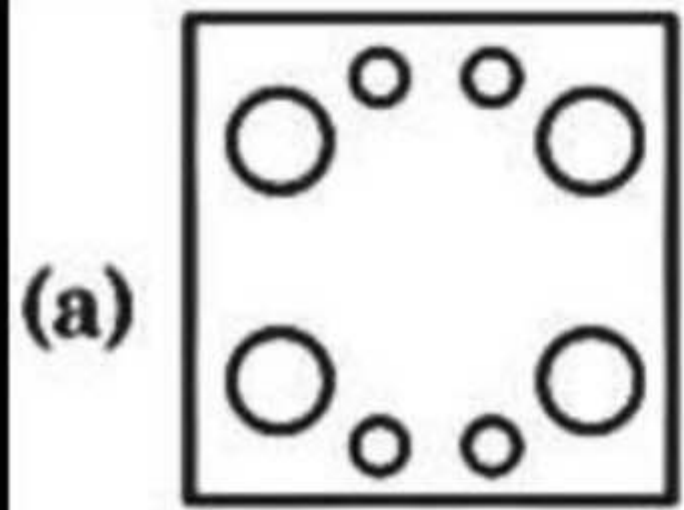
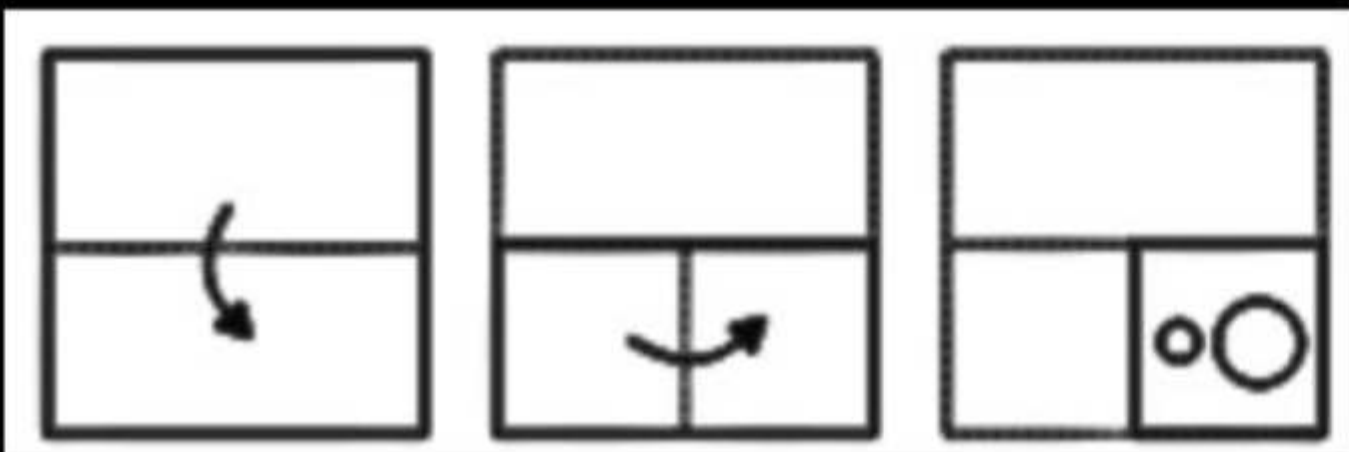

9.

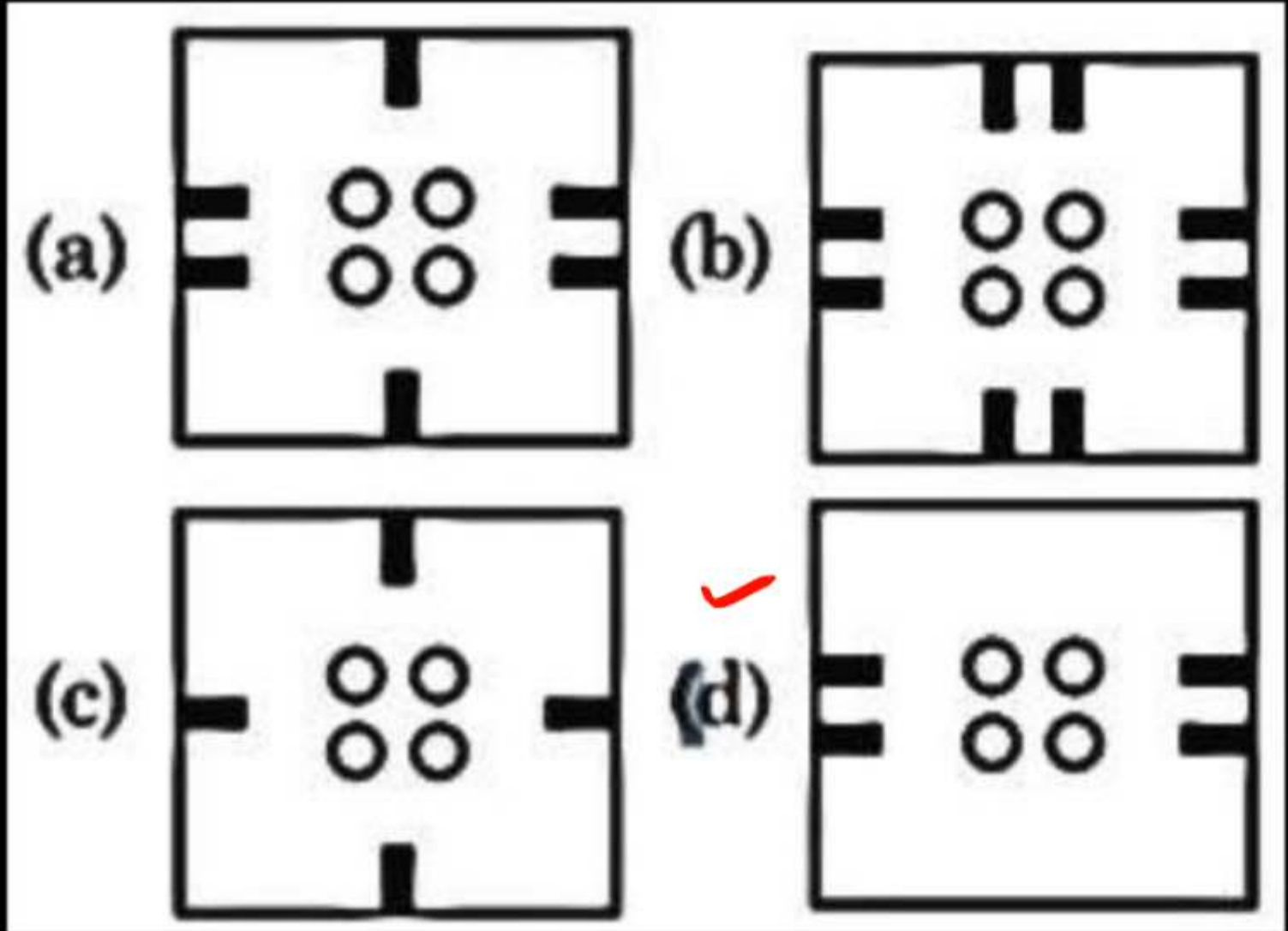
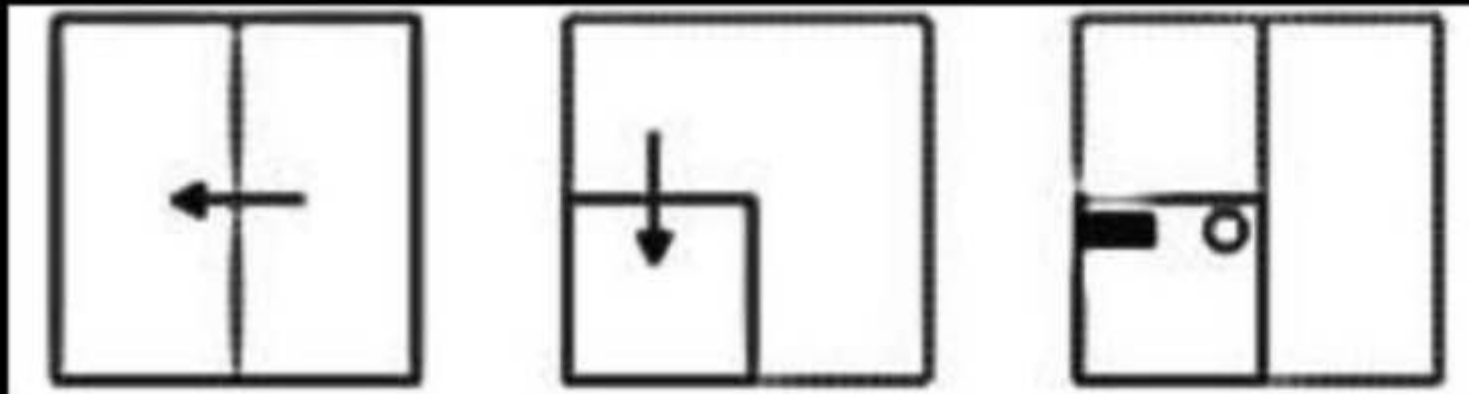

10.

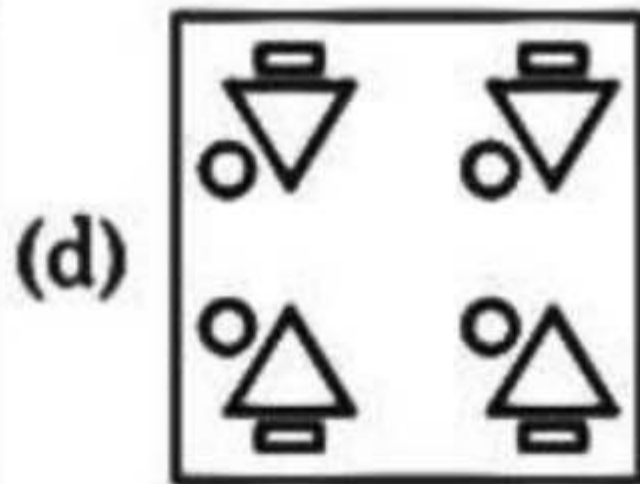
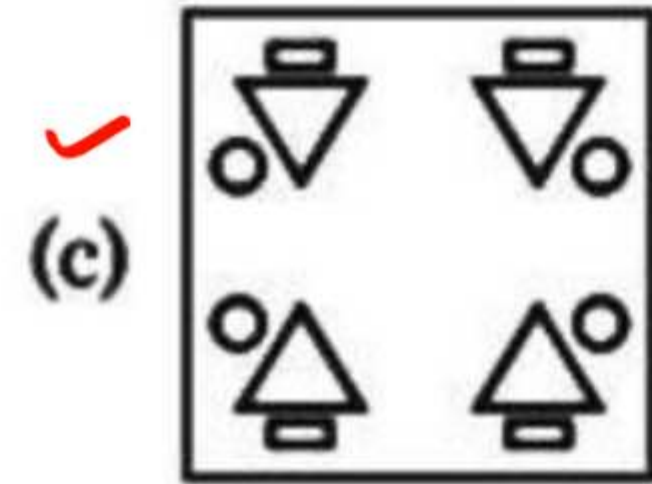
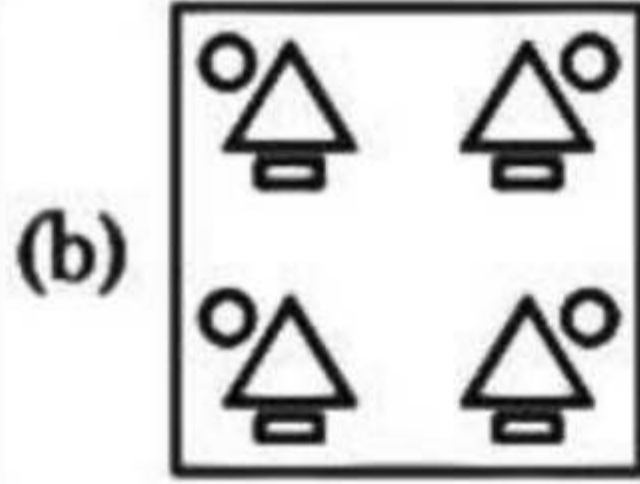
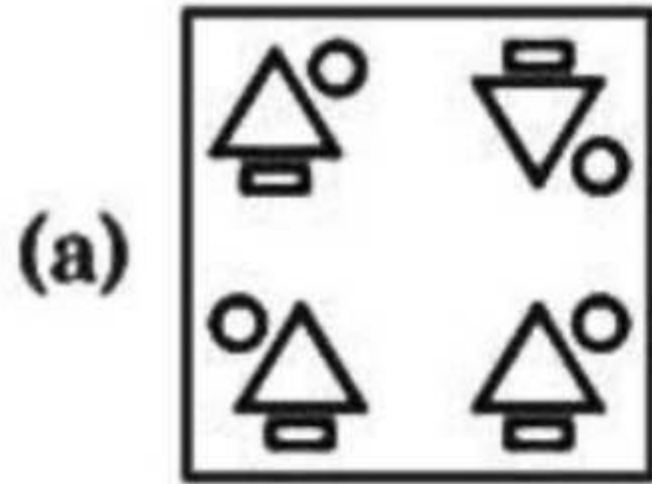
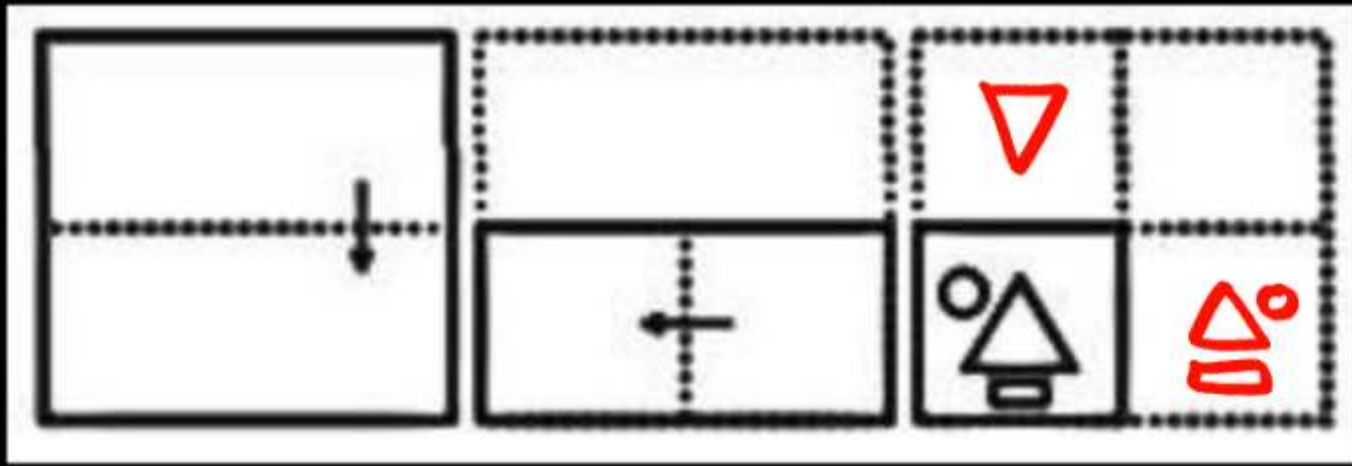

11.

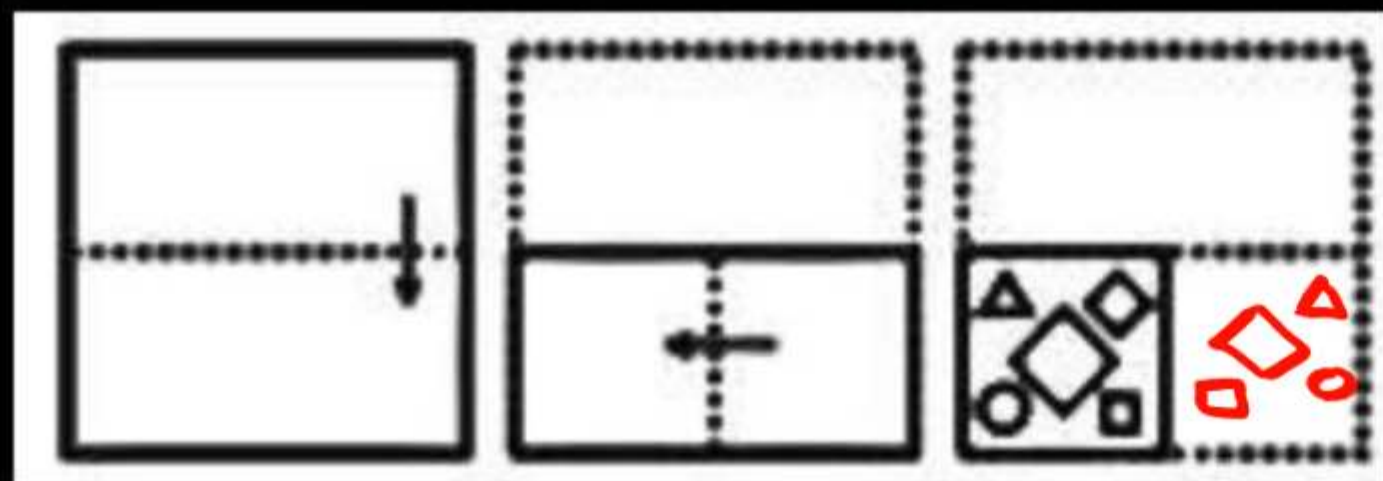

(a)

(b)

(c)

(d)



12.

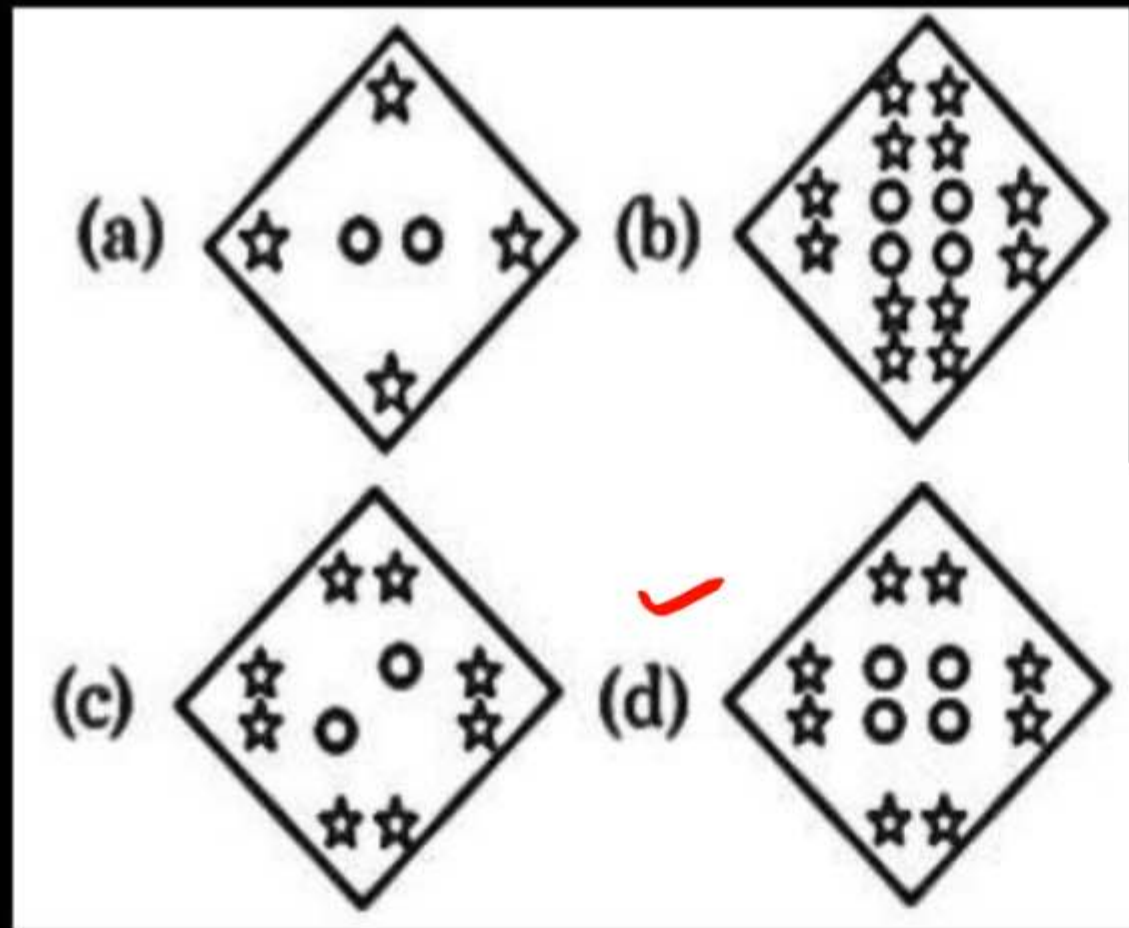
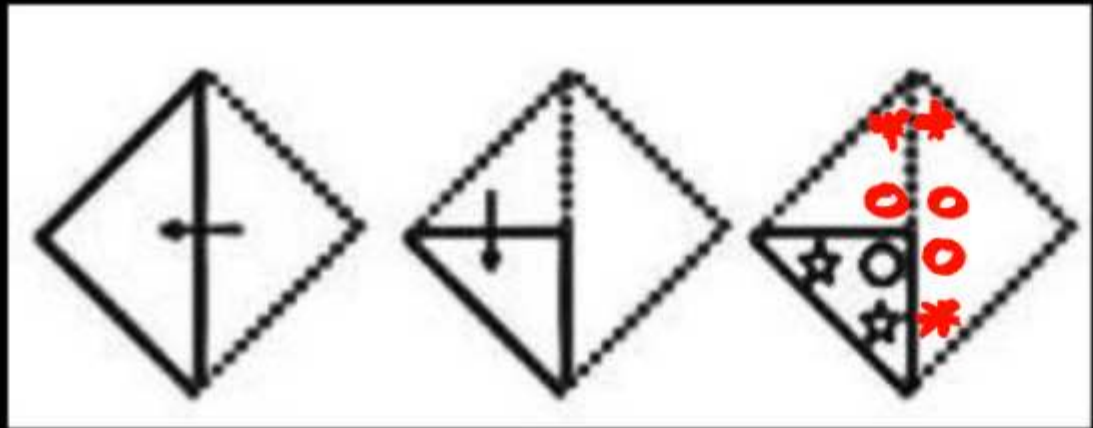

13.

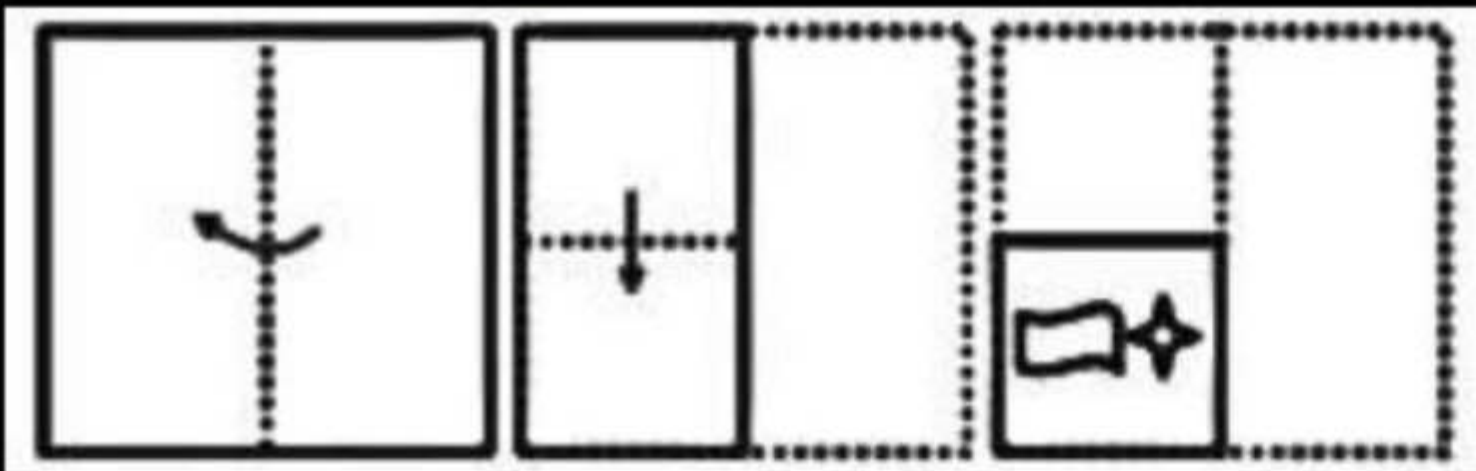

(a) 

(b) 



(c) ✓ 

(d) 

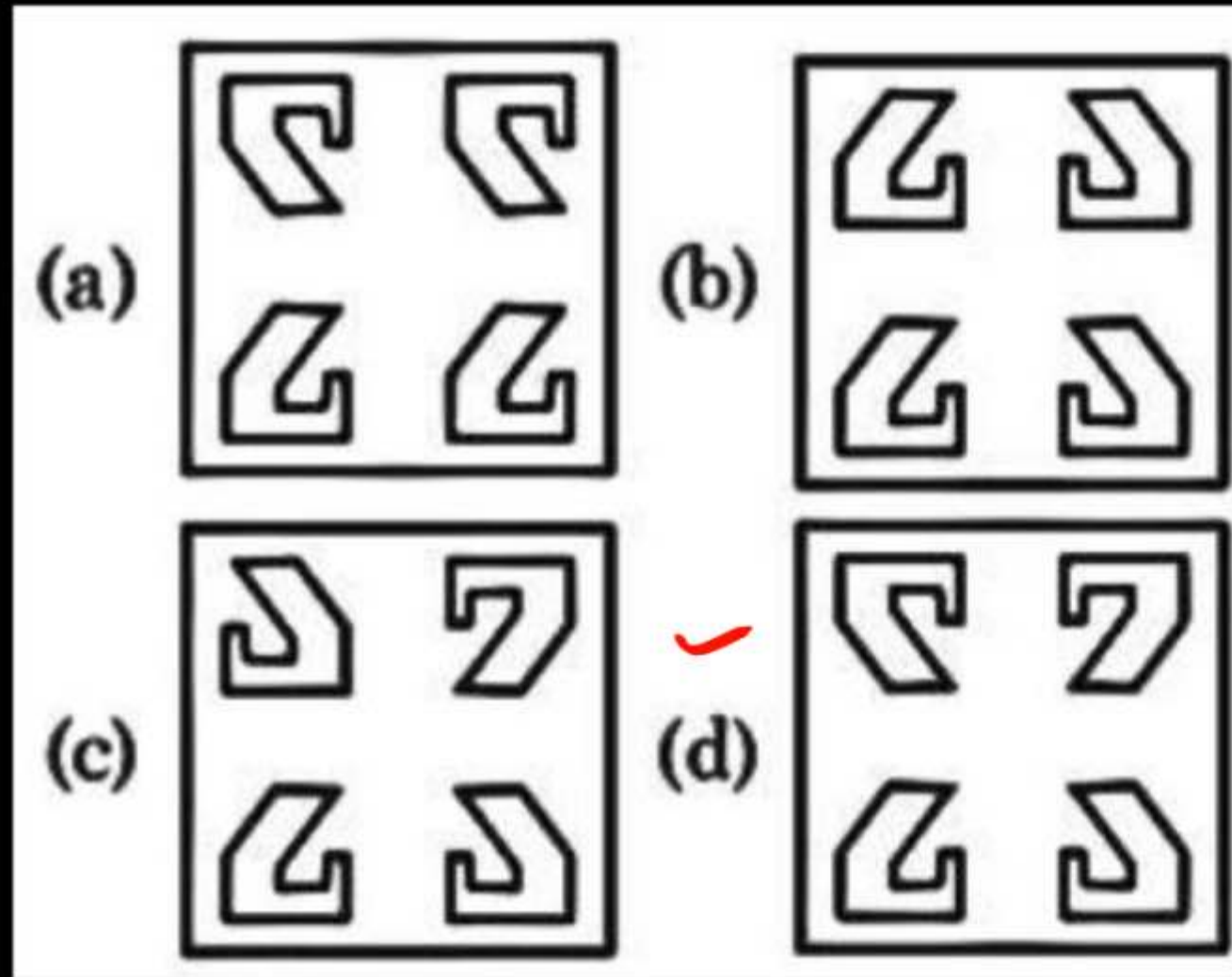
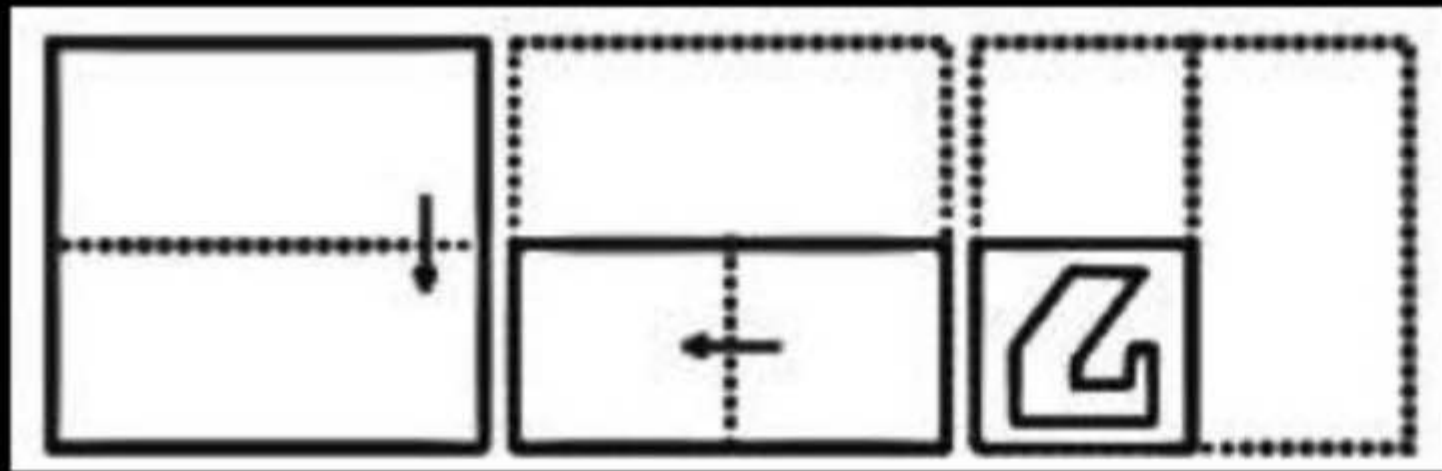

14.

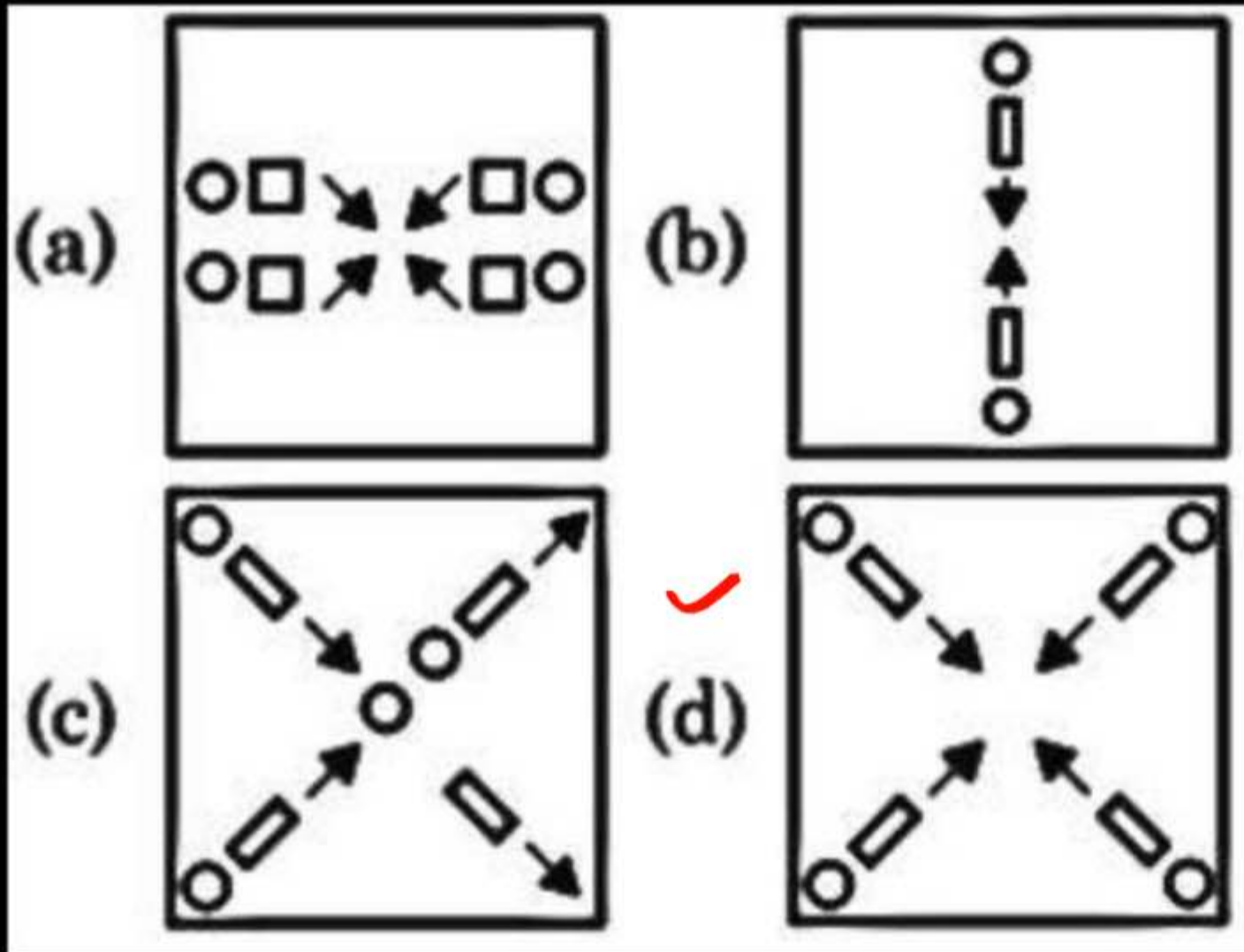
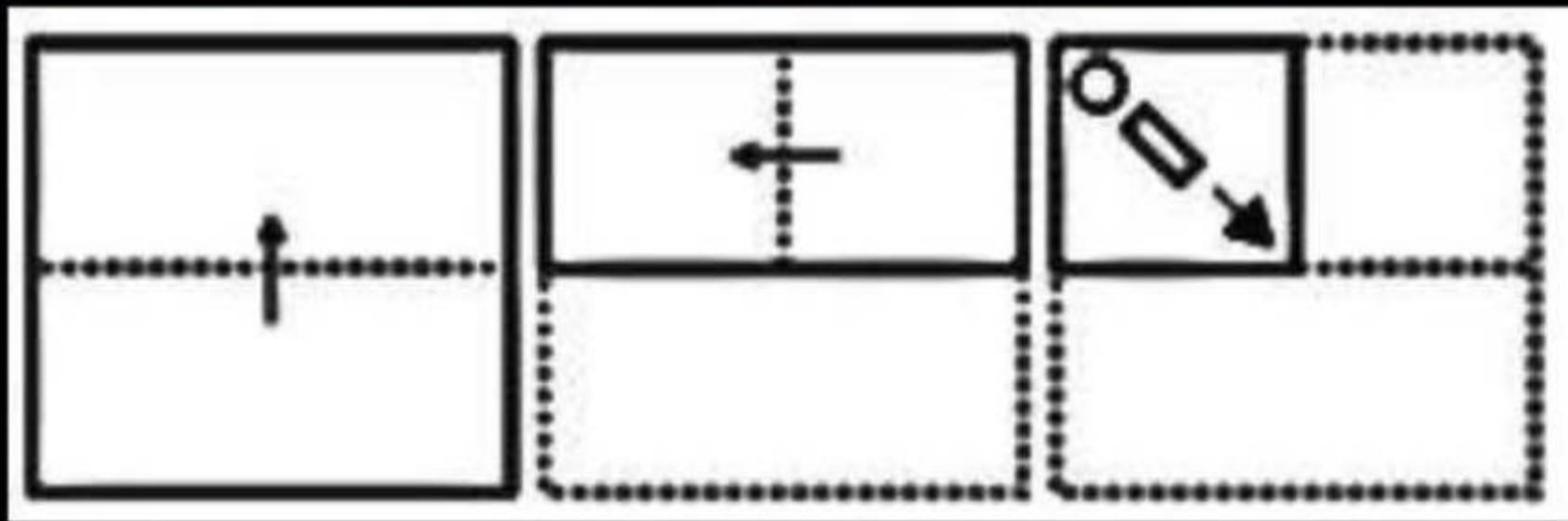

15.

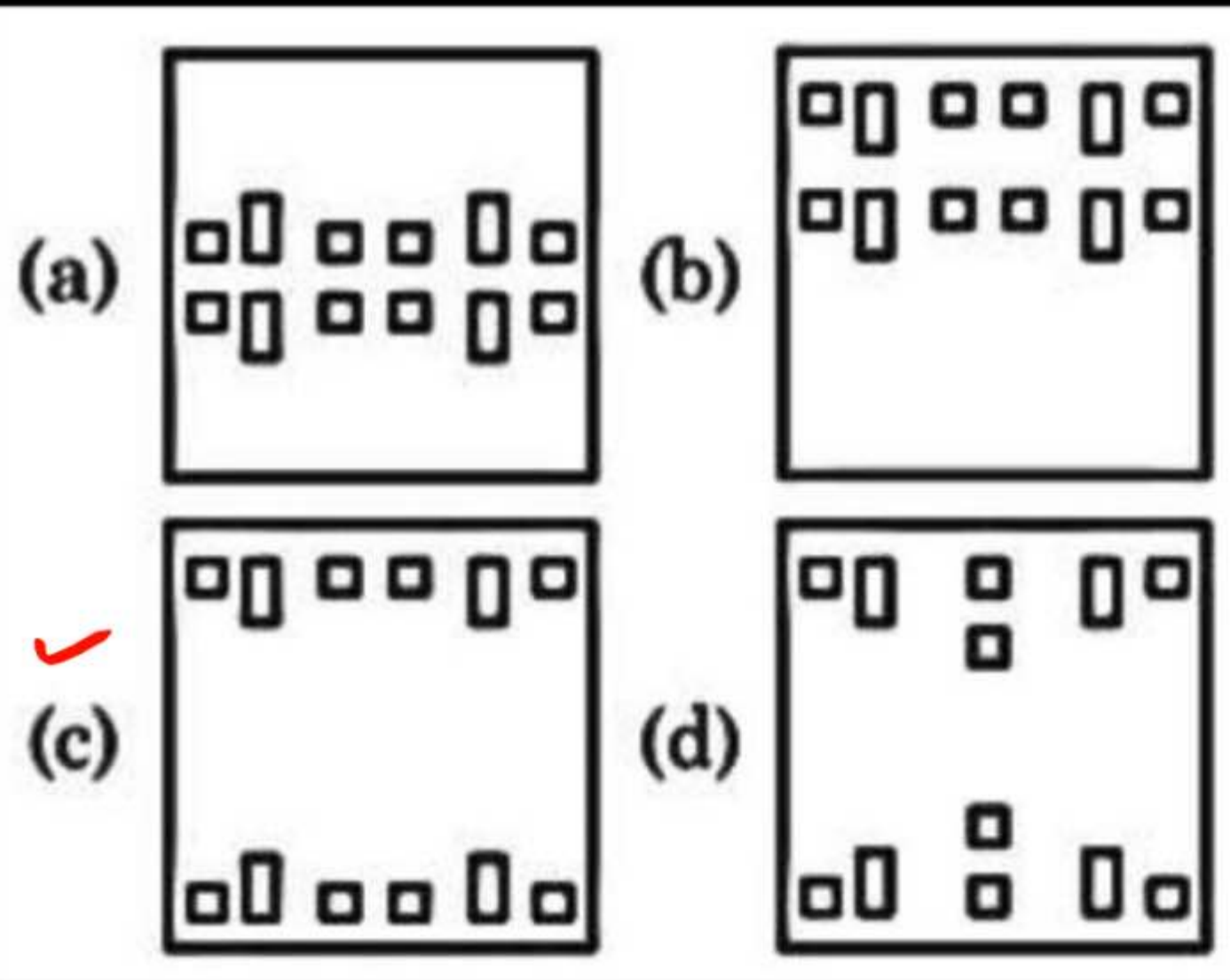
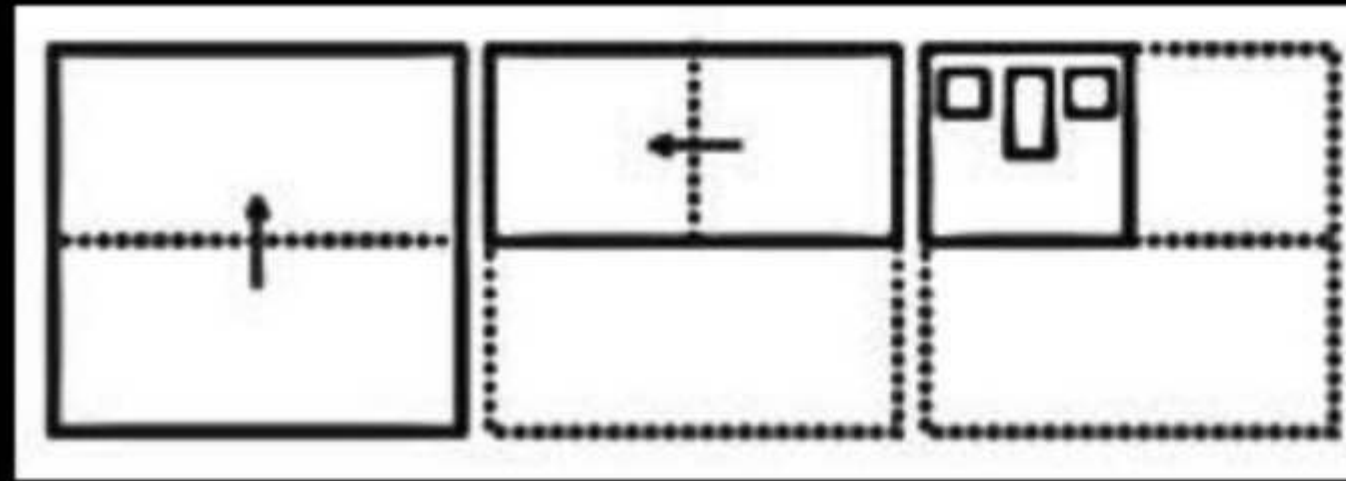

16.



17.

